



**Flammable, toxic and  
Oxygen gas detector for  
industrial applications**

# Sensepoint XCD



## One-Stop Shop

- Flammable (catalytic or infrared), toxic and Oxygen versions available
- New and retrofit applications
- Suitable for indoor or outdoor use
- Stainless steel or aluminium explosion-proof housing options
- IP66 as standard

## Proven and Reliable Sensor Technology

- Surecell™ electrochemical sensors
- Poison immune infrared sensors
- Poison resistant catalytic bead sensors
- Long life sensors

## Global Approvals

- European, North American and Asian
- Compliant with ATEX, IECEx, UL/c-UL, KTL, PA, GB and CCCF standards

## Easy to Use

- User friendly and intuitive tri-colour backlit display with digits, bar graph and icons
- Fully configurable via magnetic switches
- Optional remote sensor mounting\*
- Selectable sink or source 4-20mA output
- Auto-inhibit during maintenance
- MODBUS communications for remote diagnostics/configuration\*

## Cost Effective

- Common transmitter platform
- Minimal training required
- Reduced spares
- Non-intrusive, one-man operation
- Plug-in sensor replacement
- MODBUS multi drop option offers cabling savings\*

## Simple Installation

- Plug-in display module removes to give access to terminal area
- Integral mounting bracket
- 2 x M20 or 3/4" NPT cable/conduit entries (certification dependent)
- Removable plug/socket type terminal blocks for ease of wiring
- Sink/source switch to suit preferred wiring topology

## Range of Optional Accessories

- Remote sensor mounting kit\*
- Remote sensor gassing kit
- Duct mounting kit
- Calibration gas flow housing
- Collecting cone

\*Contact Honeywell Analytics for availability of these options.

## Typical Applications

- Industrial manufacturing facilities
- Power plants
- Waste water facilities
- Utilities
- Food and beverage production
- Refineries and chemical plants
- Onshore oil and gas terminals
- Production platforms
- Exploration and drilling

**The Sensepoint XCD range provides comprehensive monitoring of flammable, toxic and Oxygen gas hazards in potentially explosive atmospheres, both indoors and outdoors. Users can modify detector operation using the LCD and magnet switches without ever needing to open the unit. This enables one-man, non-intrusive operation and reduces routine maintenance time and costs.**

A tri-colour backlit LCD clearly indicates the unit's status at a glance, even from a distance. A steady green backlight indicates normal operation, flashing yellow indicates fault and flashing red indicates an alarm.

All detectors are supplied pre-configured and include 2 programmable alarm relays, 1 programmable fault relay as well as an industry standard 4-20mA output (sink or source selectable) and MODBUS\*.

The scale, range, relay operation, alarm set point and electronic tag number of the detector can be adjusted using the transmitter's LCD and non-intrusive magnetic switches. Outputs are automatically inhibited during adjustment, thereby reducing the risk of false alarm at the control panel during maintenance.

Sensepoint XCD has an integral mounting plate for surface mounting or can be mounted to a horizontal or vertical pipe using the optional pipe mounting bracket. Electrical installation can be made using either conduit or cable with suitable mechanical protection. Two M20 or 3/4" NPT entries are provided (depending on certification). A weatherproof cap is also included for use in the harshest outdoor conditions. Other optional accessories include a sunshade/deluge protection, duct mounting kit, collecting cone and remote mounting sensor socket\*.

Sensepoint XCD ensures easy installation and the fastest routine operation by removing the need for hot work permits in hazardous areas. Using easy to replace plug-in sensors, downtime is also reduced and on-going costs are minimised through the use of poison resistant flammable sensors, poison immune infrared Hydrocarbon sensors and patented Surecell™ toxic sensors.



1. Cover
2. Display module
3. Terminal area
4. Blanking plug
5. Transmitter
6. Plug-in XCD sensor
7. Sensor retaining ring
8. Integral mounting plate
9. Weather protection assembly
10. Cable/conduit entry (x2)
11. Certification label

# Sensepoint XCD Overview



There are three different types of the XCD transmitter for use with three different families of sensors.

The mV type transmitter is for use with the mV family of XCD sensors including catalytic sensors to detect flammable gases in the range 0-100%LEL and infrared (IR) sensors for detection of Hydrocarbon gases in the range 0-100%LEL and 0-100%Vol\*, as well as Carbon Dioxide (CO<sub>2</sub>) in the range 0-2%Vol.

The EC type transmitter is for use with the EC family of XCD sensors including Carbon Monoxide (CO), Hydrogen Sulphide, (H<sub>2</sub>S) and Hydrogen (H<sub>2</sub>).

The Oxygen transmitter is for use with the Oxygen (O<sub>2</sub>) XCD sensors.

A transmitter can auto-recognise any sensor from within its sensor family. The sensor simply plugs into the bottom of the transmitter and the transmitter automatically configures itself accordingly.

Sensepoint XCD Sensor Families, Gases and Ranges								
	Gas	User Selectable Full Scale Range	Default Range	Steps	Selectable Cal Gas Range	Default Cal Point		
Sensor Family	mV	<b>Catalytic Bead Sensors</b>						
		Flammable 1 to 8*	20 to 100%LEL	100%LEL	10%LEL	30 to 70% of selected full scale range	50%LEL	
		<b>Infrared Sensors</b>						
		Methane	20 to 100%LEL	100%LEL	10%LEL		50%LEL	
		Methane	20 to 100%Vol.*	100%Vol.	10%Vol.		50%Vol.	
		Carbon Dioxide	2.00%Vol. only	2.00%Vol.	n/a		1.00%Vol.	
		<b>Electrochemical Sensors</b>						
		Hydrogen Sulphide	10.0 to 100.0ppm	50.0ppm	0.1ppm		25ppm	
		Carbon Monoxide	100 to 1,000ppm	300ppm	100ppm		100ppm	
		Hydrogen	1,000ppm only	1,000ppm	n/a		500ppm	
O <sub>2</sub>	Oxygen	25.0%Vol. only	25.0%Vol.	n/a	20.9%Vol. (Fixed)		20.9%Vol.	

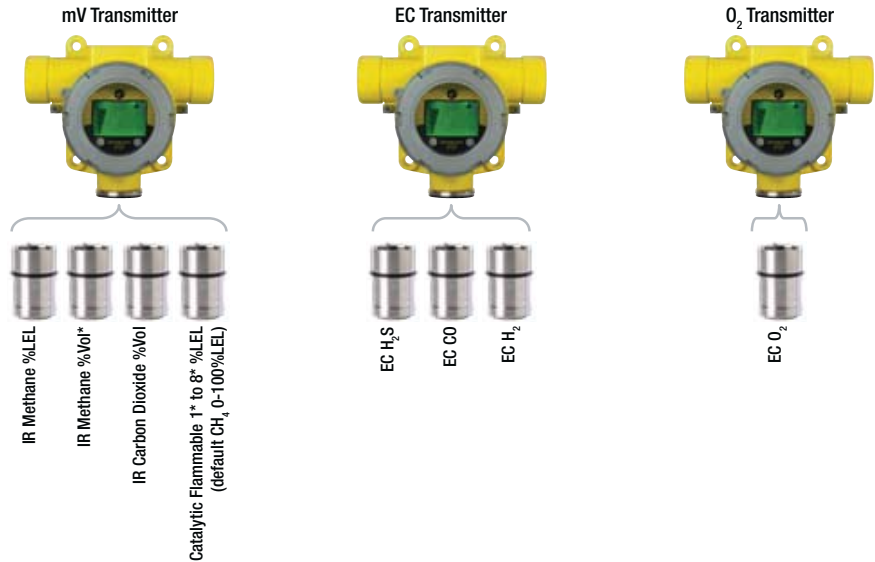

## Ready, Steady, Go!

Sensepoint XCD uses three instantly recognisable 'traffic light' colours to indicate its status. The large tri-colour backlit LCD is steady green to indicate normal operation, flashes yellow to indicate a fault/warning and flashes red to indicate an alarm. This allows anyone in the area to clearly see at a glance the status of any detector. This can be particularly useful to identify detector status if the detector is located in a difficult to access area or if a number of detectors are located in the same area.



# Installation



## Outline Installation Dimensions

The Sensepoint XCD transmitter has an integral mounting plate consisting of four mounting holes on the transmitter body. The transmitter may be fixed directly to a surface mounting, or to a horizontal or vertical pipe/structure, 40.0-80.0mm (1.6 to 3.1") in diameter/cross section. The pipe mounting bracket accessory (optional) may be used for this purpose.

User cable entries shown (2 x M20) are for ATEX/IECEX version enclosures. UL/c-UL versions have 2 x 3/4"NPT conduit entries. A suitable blanking plug is supplied which must be used to seal any unused entry. The blanking plug must be suitably sealed to maintain the IP rating of the detector.

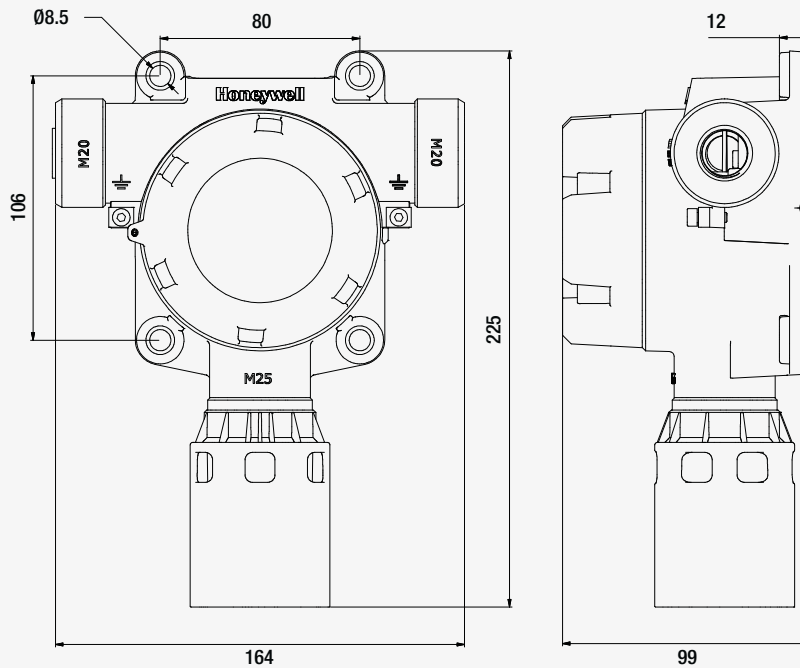

All dimensions in mm.  
1" = 25.4mm

## Installation Options

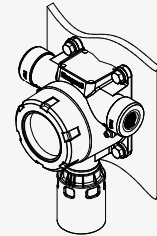

Wall Mounted

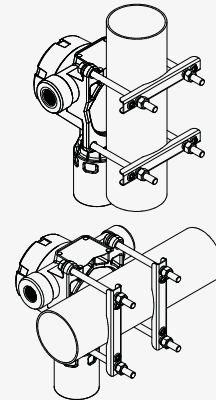

Vertical or horizontal pipe mounted  
(Using optional pipe mounting bracket)

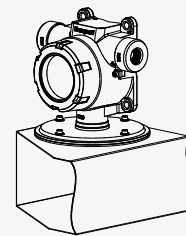

Duct Mounted

## Other Accessories

Various accessories are available for different applications:

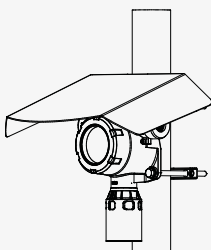

Sunshade/Deluge protection

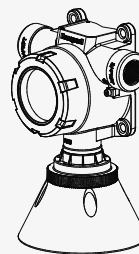
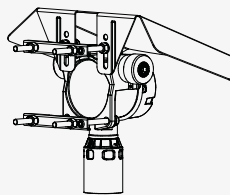

Collecting Cone

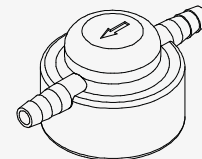

Gassing Cap

# Installation



## Electrical

Sensepoint XCD is designed for use in potentially explosive atmospheres. As such, installation should follow national guidelines using suitable mechanically protected cable and glands or conduit. Use 0.5mm<sup>2</sup> (20AWG) to 2.5mm<sup>2</sup> (~13AWG) cross sectional area cable as needed to ensure minimum operating voltage at the detector, depending on installed cable length. Cable diameter should be selected to maintain the minimum required voltage for the longest installed cable length under maximum power.

### Terminal Module Connections

Terminal Number	Marking	Connection	Description
1	24V	+VE Supply (16 - 32VDC)	Controller Connections
2	0V	-VE Supply (0VDC)	
3	4~20mA	Current Output Signal	
4	COM	Drain	MODBUS RTU. RS485 (Pending)
5	TxD	MODBUS B (+)	
6	RxD	MODBUS A (-)	Programmable Relay 1 (Default A1)
7	RLY1/NC	Normally Closed	
8	RLY1/COM	Common	
9	RLY1/NO	Normally Open	Programmable Relay 2 (Default A2)
10	RLY2/NC	Normally Closed	
11	RLY2/COM	Common	Programmable Relay 3 (Default Fault)
12	RLY2/NO	Normally Open	
13	RLY3/NC	Normally Closed	
14	RLY3/COM	Common	Programmable Relay 3 (Default Fault)
15	RLY3/NO	Normally Open	

Internal Earth/  
Ground Point

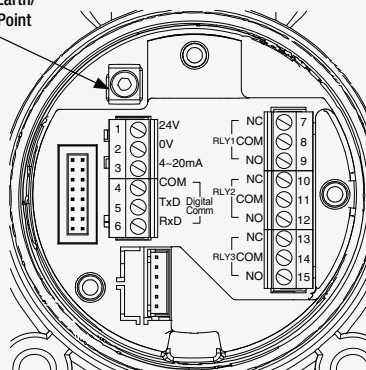

Terminal Module

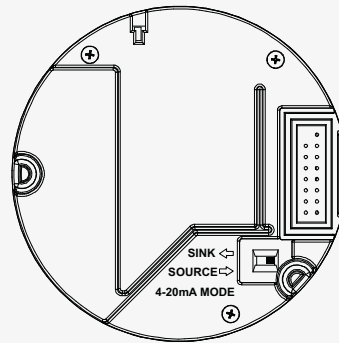

Puck Rear View

Note: Terminal Blocks are plug/socket type and may be removed to ease wiring.

## Typical Cable Lengths

Typical Cable Data			Maximim Cable Length					
Cable Size (Cross Sectional Area)	Cable Resistance		Catalytic		EC		IR	
	Ω/km	Ω/mi	Metres	Feet	Metres	Feet	Metres	Feet
0.5mm <sup>2</sup> (20AWG*)	36.8	59.2	356	1167	478	1568	420	1379
1.0mm <sup>2</sup> (17AWG*)	19.5	31.4	671	2201	902	2956	793	2599
1.5mm <sup>2</sup> (16AWG*)	12.7	20.4	1031	3387	1384	4549	1217	4000
2.0mm <sup>2</sup> (14AWG*)	10.1	16.3	1296	4239	1741	5694	1531	5006
2.5mm <sup>2</sup> (13AWG*)	8	12.9	1636	5356	2197	7194	1932	6326

Note: Table given for guidance only. Users should calculate maximum distances using actual data for cable being used. Typical calculation assumes minimum guaranteed controller supply of 24VDC, minimum detector voltage of 16VDC and maximum power supply under full alarm. R<sub>L</sub> (max) is 250ohms.

## Wiring Schematics

The Sensepoint XCD transmitter may be wired in either Current Sink or Current Source configuration. These two options are offered to allow greater flexibility in the type of control system that it can be used with. Sink/Source is selectable via the switch located on the back side of the display module; accessible by removing the display module during installation/ commissioning.

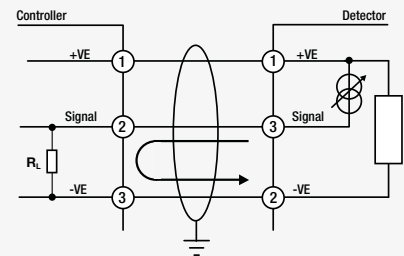

XCD Source Configuration

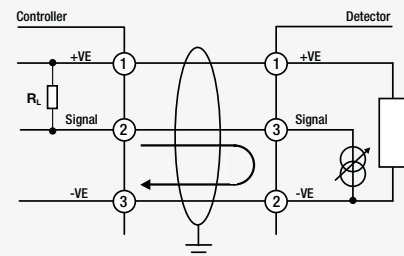

XCD Sink Configuration

Note: Terminate cable screen at the detector or the controller, not both.



# Technical Summary



Sensepoint XCD Detector																																																																																																																																			
<b>Use</b>	3 wire, 4-20mA and RS485 MODBUS* output fixed point detector with in-built alarm and fault relays for the protection of personnel and plant from flammable, toxic and Oxygen hazards. Incorporating a transmitter with local display and fully configurable via non-intrusive magnetic switch interface. Wide range of local and remote sensors available.																																																																																																																																		
<b>Electrical</b>	<table border="0"> <tr> <td>Input Voltage Range</td> <td colspan="11">16 to 32VDC (24VDC nominal)</td> </tr> <tr> <td>Max Power Consumption</td> <td colspan="11">Maximum power consumption is dependent on the type of gas sensor being used. Electrochemical cells = 3.7W, IR = 3.7W and catalytic = 4.9W. Maximum inrush current = 800mA at 24VDC</td> </tr> <tr> <td>Current Output</td> <td colspan="11">Sink or source</td> </tr> <tr> <td>≥0.0&lt;1.0mA</td> <td colspan="11">Fault</td> </tr> <tr> <td>2.0mA or 4.0mA (17.4mA)</td> <td colspan="11">Inhibit (during configuration/user settings)</td> </tr> <tr> <td>4.0mA to 20.0mA</td> <td colspan="11">Normal gas measurement</td> </tr> <tr> <td>22.0mA</td> <td colspan="11">Maximum over range</td> </tr> <tr> <td>Terminals</td> <td colspan="11">15 x screw terminals suitable for wire diameter 0.5mm<sup>2</sup> to 2.5mm<sup>2</sup> (20AWG to 14AWG)</td> </tr> <tr> <td>Relays</td> <td colspan="11">3 x 5A@250VAC. Selectable normally open or normally closed (switch) and energised/de-energised (programmable) Alarm relays default normally open/de-energised. Fault relay default normally open/energised</td> </tr> <tr> <td>Communication</td> <td colspan="11">RS485, MODBUS RTU (Pending)</td> </tr> </table>											Input Voltage Range	16 to 32VDC (24VDC nominal)											Max Power Consumption	Maximum power consumption is dependent on the type of gas sensor being used. Electrochemical cells = 3.7W, IR = 3.7W and catalytic = 4.9W. Maximum inrush current = 800mA at 24VDC											Current Output	Sink or source											≥0.0<1.0mA	Fault											2.0mA or 4.0mA (17.4mA)	Inhibit (during configuration/user settings)											4.0mA to 20.0mA	Normal gas measurement											22.0mA	Maximum over range											Terminals	15 x screw terminals suitable for wire diameter 0.5mm <sup>2</sup> to 2.5mm <sup>2</sup> (20AWG to 14AWG)											Relays	3 x 5A@250VAC. Selectable normally open or normally closed (switch) and energised/de-energised (programmable) Alarm relays default normally open/de-energised. Fault relay default normally open/energised											Communication	RS485, MODBUS RTU (Pending)										
Input Voltage Range	16 to 32VDC (24VDC nominal)																																																																																																																																		
Max Power Consumption	Maximum power consumption is dependent on the type of gas sensor being used. Electrochemical cells = 3.7W, IR = 3.7W and catalytic = 4.9W. Maximum inrush current = 800mA at 24VDC																																																																																																																																		
Current Output	Sink or source																																																																																																																																		
≥0.0<1.0mA	Fault																																																																																																																																		
2.0mA or 4.0mA (17.4mA)	Inhibit (during configuration/user settings)																																																																																																																																		
4.0mA to 20.0mA	Normal gas measurement																																																																																																																																		
22.0mA	Maximum over range																																																																																																																																		
Terminals	15 x screw terminals suitable for wire diameter 0.5mm <sup>2</sup> to 2.5mm <sup>2</sup> (20AWG to 14AWG)																																																																																																																																		
Relays	3 x 5A@250VAC. Selectable normally open or normally closed (switch) and energised/de-energised (programmable) Alarm relays default normally open/de-energised. Fault relay default normally open/energised																																																																																																																																		
Communication	RS485, MODBUS RTU (Pending)																																																																																																																																		
<b>Construction</b>	<table border="0"> <tr> <td><b>Material</b></td> <td colspan="11"> <table border="0"> <tr> <td>Housing</td> <td colspan="11">Epoxy painted aluminium alloy LM25 or 316 stainless steel</td> </tr> <tr> <td>Sensor</td> <td colspan="11">316 stainless steel</td> </tr> <tr> <td>Weather Protection</td> <td colspan="11">Plastic</td> </tr> </table> </td> </tr> <tr> <td><b>Weight (approx)</b></td> <td colspan="11"> <table border="0"> <tr> <td>Aluminium Alloy LM25</td> <td colspan="11">2.0kg (4.4lbs)</td> </tr> <tr> <td>316 Stainless Steel</td> <td colspan="11">5.0kg (11lbs)</td> </tr> </table> </td> </tr> <tr> <td><b>Mounting</b></td> <td colspan="11">Integral mounting plate with 4 x mounting holes suitable for M8 bolts Optional pipe mounting kit for horizontal or vertical pipe Ø1.5 to 3" (2" nominal)</td> </tr> <tr> <td><b>Entries</b></td> <td colspan="11">European ATEX/IECEx versions: 2 x M20 cable entries North American UL/c-UL versions: 2 x ¾"NPT conduit entries. Suitable blanking plug supplied for use if only 1 entry used. Seal to maintain IP rating</td> </tr> </table>											<b>Material</b>	<table border="0"> <tr> <td>Housing</td> <td colspan="11">Epoxy painted aluminium alloy LM25 or 316 stainless steel</td> </tr> <tr> <td>Sensor</td> <td colspan="11">316 stainless steel</td> </tr> <tr> <td>Weather Protection</td> <td colspan="11">Plastic</td> </tr> </table>											Housing	Epoxy painted aluminium alloy LM25 or 316 stainless steel											Sensor	316 stainless steel											Weather Protection	Plastic											<b>Weight (approx)</b>	<table border="0"> <tr> <td>Aluminium Alloy LM25</td> <td colspan="11">2.0kg (4.4lbs)</td> </tr> <tr> <td>316 Stainless Steel</td> <td colspan="11">5.0kg (11lbs)</td> </tr> </table>											Aluminium Alloy LM25	2.0kg (4.4lbs)											316 Stainless Steel	5.0kg (11lbs)											<b>Mounting</b>	Integral mounting plate with 4 x mounting holes suitable for M8 bolts Optional pipe mounting kit for horizontal or vertical pipe Ø1.5 to 3" (2" nominal)											<b>Entries</b>	European ATEX/IECEx versions: 2 x M20 cable entries North American UL/c-UL versions: 2 x ¾"NPT conduit entries. Suitable blanking plug supplied for use if only 1 entry used. Seal to maintain IP rating																						
<b>Material</b>	<table border="0"> <tr> <td>Housing</td> <td colspan="11">Epoxy painted aluminium alloy LM25 or 316 stainless steel</td> </tr> <tr> <td>Sensor</td> <td colspan="11">316 stainless steel</td> </tr> <tr> <td>Weather Protection</td> <td colspan="11">Plastic</td> </tr> </table>											Housing	Epoxy painted aluminium alloy LM25 or 316 stainless steel											Sensor	316 stainless steel											Weather Protection	Plastic																																																																																														
Housing	Epoxy painted aluminium alloy LM25 or 316 stainless steel																																																																																																																																		
Sensor	316 stainless steel																																																																																																																																		
Weather Protection	Plastic																																																																																																																																		
<b>Weight (approx)</b>	<table border="0"> <tr> <td>Aluminium Alloy LM25</td> <td colspan="11">2.0kg (4.4lbs)</td> </tr> <tr> <td>316 Stainless Steel</td> <td colspan="11">5.0kg (11lbs)</td> </tr> </table>											Aluminium Alloy LM25	2.0kg (4.4lbs)											316 Stainless Steel	5.0kg (11lbs)																																																																																																										
Aluminium Alloy LM25	2.0kg (4.4lbs)																																																																																																																																		
316 Stainless Steel	5.0kg (11lbs)																																																																																																																																		
<b>Mounting</b>	Integral mounting plate with 4 x mounting holes suitable for M8 bolts Optional pipe mounting kit for horizontal or vertical pipe Ø1.5 to 3" (2" nominal)																																																																																																																																		
<b>Entries</b>	European ATEX/IECEx versions: 2 x M20 cable entries North American UL/c-UL versions: 2 x ¾"NPT conduit entries. Suitable blanking plug supplied for use if only 1 entry used. Seal to maintain IP rating																																																																																																																																		
Detectable Gases and XCD Sensor Performance																																																																																																																																			
Gas	User Selectable Full Scale Range	Default Range	Steps	User Selectable Cal Gas Range	Default Cal Point	Response Time (T90) Secs	Accuracy	Operating Temperature*		Default Alarm Points																																																																																																																									
								Min	Max	A1	A2																																																																																																																								
<b>Electrochemical Sensors</b>																																																																																																																																			
Oxygen	25.0%Vol. only	25.0%Vol.	n/a	20.9%Vol. (Fixed)	20.9%Vol.	<30	<+/-0.5%Vol.	-20°C / -4°F	55°C / 131°F	19.5%Vol. ▼	23.5%Vol. ▲																																																																																																																								
Hydrogen Sulphide	10.0 to 100.0ppm	50.0ppm	1ppm	30 to 70% of selected full scale range	25ppm	<50	<+/-1ppm	-20°C / -4°F	55°C / 131°F	10ppm ▲	20ppm ▲																																																																																																																								
Carbon Monoxide	100 to 1,000ppm	300ppm	100ppm		100ppm	<30	<+/-6ppm	-20°C / -4°F	55°C / 131°F	100ppm ▲	200ppm ▲																																																																																																																								
Hydrogen	1,000ppm only	1,000ppm	n/a		500ppm	<65	<+/-25ppm	-20°C / -4°F	55°C / 131°F	200ppm ▲	400ppm ▲																																																																																																																								
<b>Catalytic Bead Sensors</b>																																																																																																																																			
Flammable 1 to 8*	20 to 100%LEL	100%LEL	10%LEL	30 to 70% of selected full scale range	50%LEL	<25	<+/-1.5%LEL	-20°C / -4°F	55°C / 131°F	20%LEL ▲	40%LEL ▲																																																																																																																								
<b>Infrared Sensors</b>																																																																																																																																			
Methane	20 to 100%LEL	100%LEL	10%LEL		50%LEL	<40	<+/-1.5%LEL	-20°C / -4°F	50°C / 122°F	20%LEL ▲	40%LEL ▲																																																																																																																								
Methane*	20 to 100%Vol.	100%Vol.	10%Vol.		50%Vol.	<40	<+/-1%Vol.	-20°C / -4°F	50°C / 122°F	20%Vol. ▲	40%Vol. ▲																																																																																																																								
Carbon Dioxide	2.00%Vol.	2.00%Vol.	n/a	1.00%Vol.	<40	<+/-0.04%Vol.	-20°C / -4°F	50°C / 122°F	0.40%Vol. ▲	0.80%Vol. ▲																																																																																																																									

▲ - Rising Alarm ▼ - Falling Alarm

**NOTES**

Performance data is: 1. Taken at nominal 20°C, 50%RH. 2. Applicable over the range 10 to 90% full scale. 3. Measured on units calibrated at 50% full scale. 4. Accuracy at 10% of default full scale (typical A1 alarm) of applied gas, or minimum (whichever is greater). 5. Measured at 500ml/min for IR, Toxics and O<sub>2</sub>, 1 Ltr/min for Catalytic bead using the calibration cup (S3KCAL).

\*Extended operating temperature range of -40°C to +65°C (-40°F to +149°F) for all sensors except for IR and H<sub>2</sub> EC sensors, with an accuracy of +/- 30% of applied gas from -20°C to -40°C (-4°F to -40°F) and +55°C to +65°C (+131°F to +149°F). Long term operation at this range may cause decline in sensor performance. Contact Honeywell Analytics for any additional data or details.

**Certification\***

<b>European</b>	ATEX Ex II 2 GD Ex d IIC Gb T6 (Ta -40°C to +65°C) Ex tb IIIC T85°C Db IP66
<b>International</b>	IEC Ex d IIC Gb T6 (Ta -40°C to +65°C) Ex tb IIIC T85°C Db IP66
<b>China</b>	GB Ex d IIC T4 GB3836.1&2 -2000, PA, CCCF
<b>Korea</b>	KTL Ex d IIC T6 (-40°C to +65°C)
<b>North America</b>	UL/c-UL - Class I, Division 1, Groups B, C and D, Class I, Division 2, Groups B, C & D, Class II, Division 1, Groups E, F & G, Class II, Division 2, Groups F & G. -40°C to +65°C

**EMC** CE: EN50270:2006 EN6100-6-4:2007

**Performance** ATEX, IEC/EN60079-29-1:2007, EN45544, EN50104, EN50271  
China: PA Pattern Measurement (for transmitter and toxic gas sensors)  
"CCCF" Shenyang for Flammable (fire dept approval)  
CSA C22.2-152

# Technical Summary cont. and Ordering Information



Environmental	
<b>IP Rating</b>	IP66 in accordance with EN60529:1992
<b>Certified Temperature Range</b>	-40°C to +65°C (-40°F to +149°F) Note: The detector display may become illegible at temperatures below -20°C, but the detector continues its gas monitoring function. The display is not damaged and recovers when the temperature rises back above -20°C.
<b>Operating Humidity</b>	Continuous 20-90%RH (non-condensing), Intermittent 0-99%RH (non-condensing)
<b>Operating Pressure</b>	90-110kPa
<b>Storage Conditions</b>	-25°C to +65°C (-13°F to 131°F)
Ordering Information	
<b>Standard Supply</b>	Sensepoint XCD is supplied complete with integral wall mounting plate, 2 x M20 cable entry (ATEX/IECEX) or 2 x ¾"NPT conduit entries (UL/cUL), 1 x M20 or 1 x ¾"NPT plug, Allen key for locking screw, weatherproof cap, operating magnet, sensor cartridge with retainer, quick start guide and instruction manual CD. Default settings, ranges and calibrations are 100% tested at the factory. Each unit is supplied with a calibration and test certificate.
<b>Shipping Details</b>	Shipping carton dimensions: L312mm (12.3") x W223mm (8.8") x D110mm (4.3") Approximate weight: Aluminium 2.5kg (5.5lbs), Stainless Steel 5.5kg (12.1lbs)

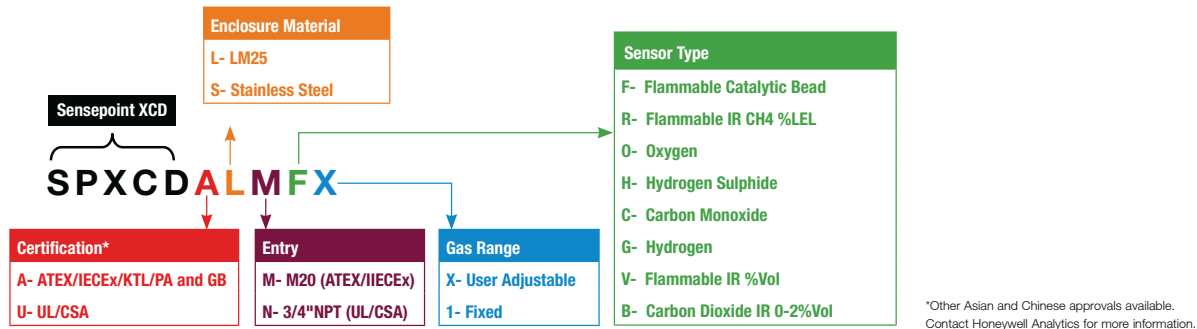

Sensepoint XCD Detector ATEX/IECEX/KTL, PA & GB (Aluminium LM25)*			
<b>SPXCDALMFX</b>	ATEX/IECEX/KTL/PA and GB approved SP XCD Flammable CAT 0-100%LEL (20 to 100%LEL, 10%LEL) with LM25, M20 Entry		
<b>SPXCDALMRX</b>	ATEX/IECEX/KTL/PA and GB approved SP XCD CH <sub>4</sub> (Methane) IR 0-100%LEL (20 to 100%LEL, 10%LEL) with LM25, M20 Entry		
<b>SPXCDALMO1</b>	ATEX/IECEX/KTL/PA and GB approved SP XCD Oxygen 25.0%/Vol. with LM25, M20 Entry		
<b>SPXCDALMHX</b>	ATEX/IECEX/KTL/PA and GB approved SP XCD Hydrogen Sulphide 0-50ppm (10.0 to 100.0ppm, 1ppm) with LM25, M20 Entry		
<b>SPXCDALMCX</b>	ATEX/IECEX/KTL/PA and GB approved SP XCD Carbon Monoxide 0-300ppm (100-1000ppm, 100ppm) with LM25, M20 Entry		
<b>SPXCDALMG1</b>	ATEX/IECEX/KTL/PA and GB approved SP XCD Hydrogen 0-1000ppm with LM25, M20 Entry		
<b>SPXCDALMV1</b>	ATEX/IECEX/KTL/PA and GB approved SP XCD Methane IR 0-100%Vol. with LM25, M20 Entry		
<b>SPXCDALMB1</b>	ATEX/IECEX/KTL/PA and GB approved SP XCD Carbon Dioxide IR 0-2.00%Vol. with LM25, M20 Entry		
Sensepoint XCD Detector ATEX/IECEX/KTL, PA & GB (316 Stainless Steel)*			
<b>SPXCDASMFx</b>	ATEX/IECEX and AP approved SP XCD Flammable CAT 0-100%LEL (20 to 100%LEL, 10%LEL) with 316SS, M20 Entry		
<b>SPXCDASMRX</b>	ATEX/IECEX and AP approved SP XCD CH <sub>4</sub> (Methane) IR 0-100%LEL (20 to 100%LEL, 10%LEL) with 316SS, M20 Entry		
<b>SPXCDASMO1</b>	ATEX/IECEX and AP approved SP XCD Oxygen 25.0%/Vol. with 316SS, M20 Entry		
<b>SPXCDASMHX</b>	ATEX/IECEX and AP approved SP XCD Hydrogen Sulphide 0-50ppm (10.0 to 100.0ppm, 1ppm) with 316SS, M20 Entry		
<b>SPXCDASMCX</b>	ATEX/IECEX and AP approved SP XCD Carbon Monoxide 0-300ppm (100-1000ppm, 100ppm) with 316SS, M20 Entry		
<b>SPXCDASMG1</b>	ATEX/IECEX and AP approved SP XCD Hydrogen 0-1000ppm with 316SS, M20 Entry		
<b>SPXCDASMV1</b>	ATEX/IECEX and AP approved SP XCD Methane IR 0-100%Vol. with 316SS, M20 Entry		
<b>SPXCDASMB1</b>	ATEX/IECEX and AP approved SP XCD Carbon Dioxide IR 0-2.00%Vol. with 316SS, M20 Entry		
Optional Accessories		Spare XCD Sensors (316 Stainless Steel)	
<b>S3KCAL</b>	Calibration cup	<b>SPXCDXSFxSS</b>	Flammable CAT 0-100%LEL (20 to 100%LEL, 10%LEL)**
<b>SPXCDCC</b>	Collecting cone for use with lighter than air gases	<b>SPXCDXSRxSS</b>	Methane IR 0-100%LEL (20 to 100%LEL, 10%LEL)**
<b>SPXCDDMK</b>	Duct mounting kit	<b>SPXCDXS01SS</b>	Oxygen 25.0%/Vol. only
<b>SPXCDHMANEN</b>	Hard copy manual in English	<b>SPXCDXSHxSS</b>	Hydrogen Sulphide 0-50ppm (10.0 to 100.0ppm, 1ppm)**
<b>SPXCDMTBR</b>	Mounting bracket (inc. bolts, nuts, brackets)	<b>SPXCDXSCxSS</b>	Carbon Monoxide 0-300ppm (100-1000ppm, 100ppm)**
<b>SPXCDSDP</b>	Sunshade/Deluge Protection	<b>SPXCDXSG1SS</b>	Hydrogen 0-1000ppm only
<b>00780-A-0100</b>	ATEX approved junction box (Explosion-proof)	<b>SPXCDXSV1SS</b>	Methane IR 0-100%Vol. only
		<b>SPXCDXSB1SS</b>	Carbon Dioxide IR 0-2.00%Vol. only

\*For UL/c-UL versions simply change the letters in the part number for certification and entry e.g. first part number in table above would become SPXCDULNFX.

\*\*For further explanation refer to "Detectable Gases and XCD Sensor Performance" table on page 6.

# Our Product Range



## Fixed Gas Monitoring

Honeywell Analytics offers a wide range of fixed gas detection solutions for a diverse array of industries and applications including: Commercial properties, industrial applications, semiconductor manufacturers, energy plants and petrochemical sites.

- » Detection of flammable, oxygen and toxic gases (including exotics)
- » Innovative use of 4 core sensing technologies – paper tape, electrochemical cell, catalytic bead and infrared
- » Capability to detect down to Parts Per Billion (ppb) or Percent by Volume (%v/v)
- » Cost effective regulatory compliance solutions

## Portable Gas Monitoring

When it comes to personal protection from gas hazards, Honeywell Analytics has a wide range of reliable solutions ideally suited for use in confined or enclosed spaces. These include:

- » Detection of flammable, oxygen and toxic gases
- » Single gas personal monitors – worn by the individual
- » Multi-gas portable gas monitors – used for confined space entry and regulatory compliance
- » Multi-gas transportable monitors – used for temporary protection of area during site construction and maintenance activities

## Technical Services

At Honeywell Analytics, we believe in the value of great service and customer care. Our key commitment is providing complete and total customer satisfaction. Here are just a few of the services we can offer:

- » Full technical support
- » Expert team on hand to answer questions and queries
- » Fully equipped workshops to ensure quick turnaround on repairs
- » Comprehensive service engineer network
- » Training on product use and maintenance
- » Mobile calibration service
- » Customised programmes of preventative/corrective maintenance
- » Extended warranties on products

### Find out more

[www.honeywellanalytics.com](http://www.honeywellanalytics.com)

### Contact Honeywell Analytics:

#### Europe, Middle East, Africa, India

Life Safety Distribution AG  
Weiherallee 11a  
CH-8610 Uster  
Switzerland  
Tel: +41 (0)44 943 4300  
Fax: +41 (0)44 943 4398  
[gasdetection@honeywell.com](mailto:gasdetection@honeywell.com)

#### Technical Services

EMEA: [HAexpert@honeywell.com](mailto:HAexpert@honeywell.com)  
US: [ha.us.service@honeywell.com](mailto:ha.us.service@honeywell.com)  
AP: [ha.ap.service@honeywell.com](mailto:ha.ap.service@honeywell.com)

[www.honeywell.com](http://www.honeywell.com)

#### Americas

Honeywell Analytics Inc.  
405 Barclay Blvd.  
Lincolnshire, IL 60069  
USA  
Tel: +1 847 955 8200  
Toll free: +1 800 538 0363  
Fax: +1 847 955 8210  
[detectgas@honeywell.com](mailto:detectgas@honeywell.com)

#### Asia Pacific

Honeywell Analytics Asia Pacific  
#508, Kolon Science Valley (I)  
187-10 Guro-Dong, Guro-Gu  
Seoul, 152-050  
Korea  
Tel: +82 (0)2 2025 0300  
Fax: +82 (0)2 2025 0329  
[analytics.ap@honeywell.com](mailto:analytics.ap@honeywell.com)

#### Please Note:

While every effort has been made to ensure accuracy in this publication, no responsibility can be accepted for errors or omissions. Data may change, as well as legislation, and you are strongly advised to obtain copies of the most recently issued regulations, standards, and guidelines. This publication is not intended to form the basis of a contract.