

Job Name	
Order No.	

HITACHI

Submittal Data Sheet	RAD-GJ09QHAA
9,000 Btu/hr Ducted Indoor Unit	



Indoor Specifications				
Airflow Rate (cfm)	Cooling		Heating	
	H	M	H	M
	300	259	309	276
	L	SL	L	SL
229	194	235	200	
Sound (dBA) H / M / SL		Cooling		Heating
		41/37/30		42/38/30
Dimensions (W x H x D) (in)		29.53 x 9.25 x 15.75		
Weight (Lbs)		35		
External Static Pressure		0.3		
Nominal Capacity (Btu/hr)		9,000		

Recommended cable between Outdoor and Indoor 14AWG - 18AWG 4 conductors stranded copper wire and Power wiring cable size must comply with applicable national and local codes.

Electrical		
	Cooling	Heating
Running Current (Rated) (A)	0.54	
Power Consumption (Rated) (W)	Refer to Outdoor	

Piping	
Liquid (in)	1/4
Gas (in)	3/8
Drain (in)	0.63

Optional Accessories:	
Description	Part Number
Remote Controller with Receiver Kit	SPX-RKDN1
Remote Controller with Receiver Kit French	SPX-RKDN3
Wired Controller	SPX-URFG1
Wi-Fi Adapter	SPX-WFA01
Extension Cable for Wi-Fi Adapter	SPX-WFG58CM
H-Link Adapter IDU	PSC-6RAD
Adapter for Wired Remote Group Controller	SPX-DST1
26.2 ft (8m) Wire Cable for Distributor SPX-DST1	SPX-WDST8M
Dry Contact	SPX-WDC3
ON/OFF Status and Alarm Signal	SPX-WDC8
Float Switch	PMRAMD-350BWR11

Factory default installation position is Bottom side suction.
 However, Back side suction installation is also allowable
 with some plate adjustment position.

Unit: inch(mm)

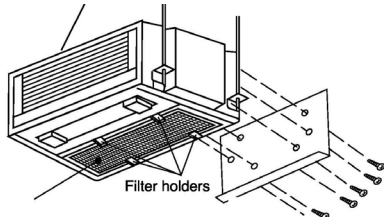

Bottom side suction opening

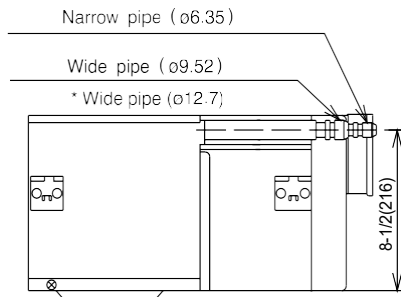

BOTTOM SUCTION

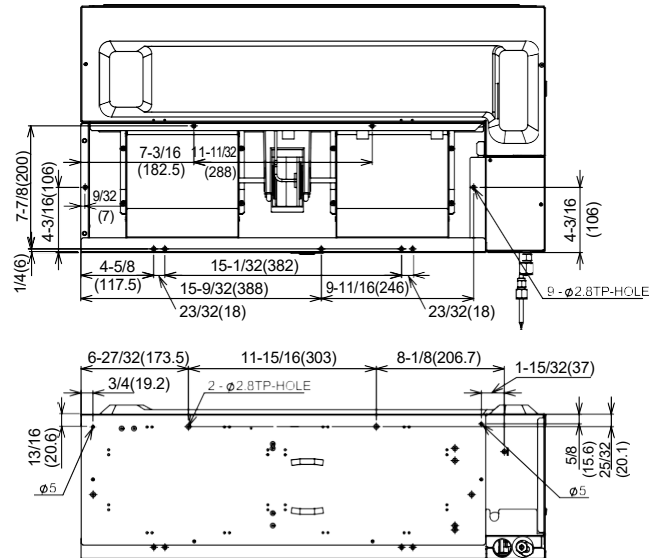

Recommended cable between Outdoor and Indoor 14AWG - 18AWG 4 conductors stranded copper wire and Power wiring cable size must comply with applicable national and local codes.

Unit: inch(mm)

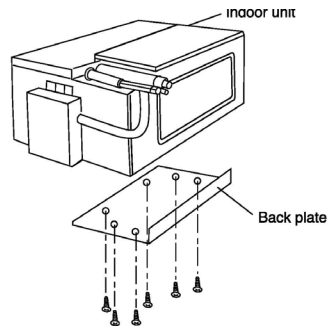

Back side suction opening

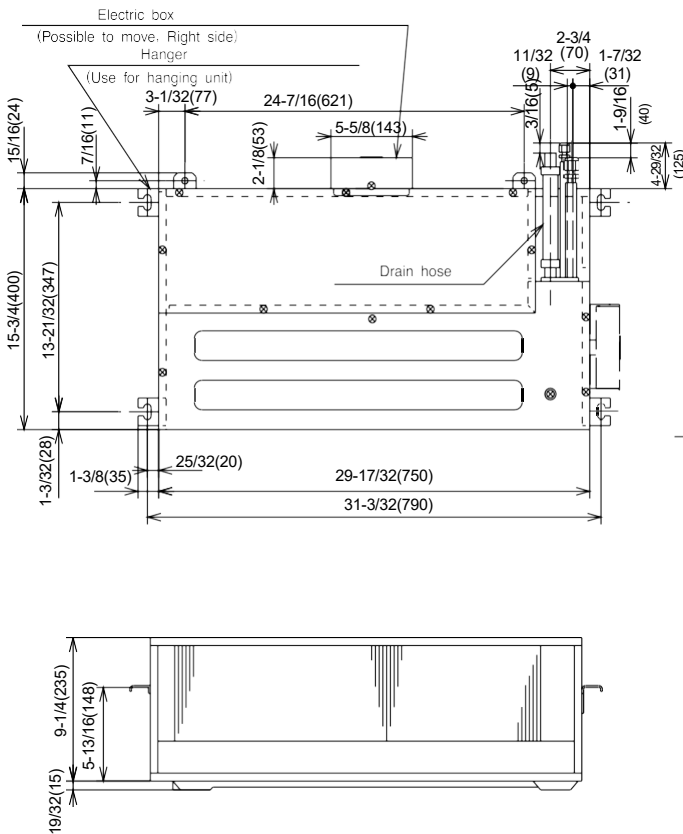

BACK SUCTION

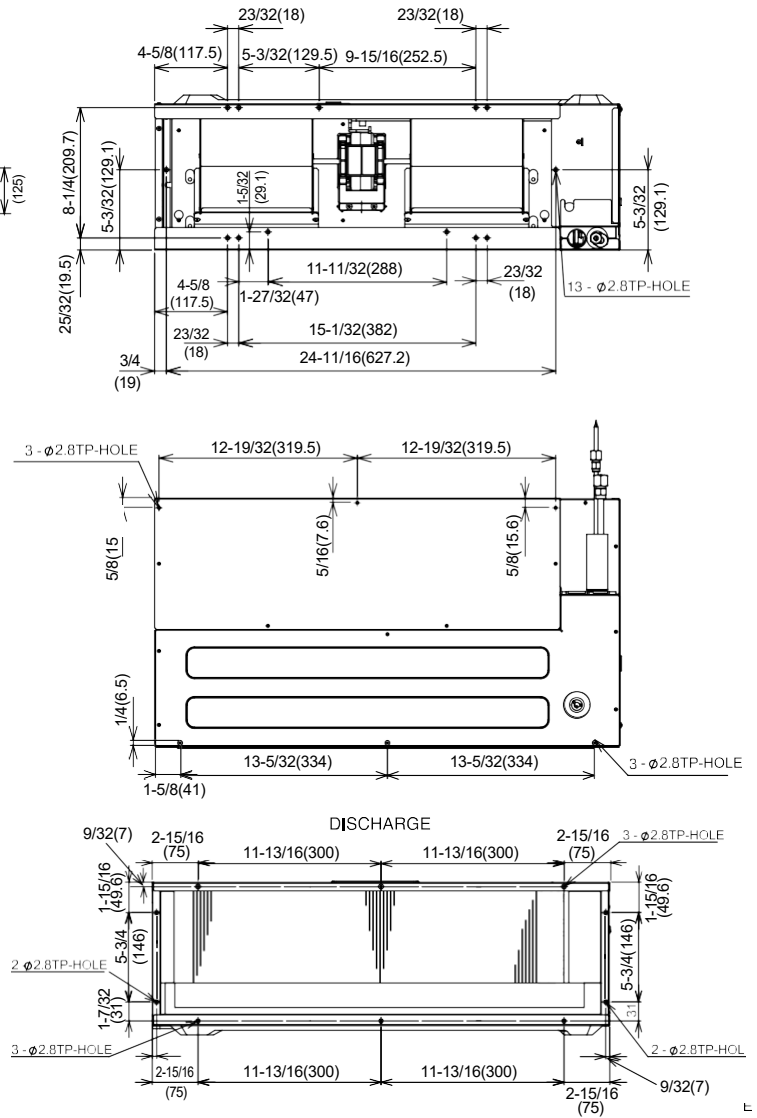

Recommended cable between Outdoor and Indoor 14AWG - 18AWG 4 conductors stranded copper wire and Power wiring cable size must comply with applicable national and local codes.

